

Medium Toggle Switch

Q-635

TYPE: **KN3(B)-101A**

SPECIFICATIONS

Rating: 10A 125V AC; 6A 250V AC
 Contact R: 50mΩ max
 Insulation R: 500V DC 100MΩ min
 Dielectric Strength: 1 Minute 1500V AC
 Operating Temperature: -25°C ~ +85°C
 Electrical Life: 10, 000 Cycles

Outline Drawing

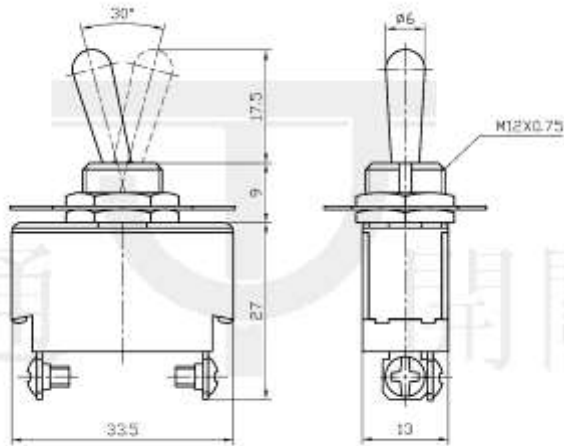

Mounting

Circuitry

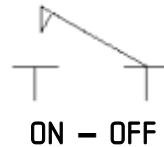
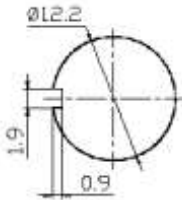

107023, Москва, ул. Буженинова, д. 16
 телефон: (495) 963-6120
 факс: (495) 963-4994
 e-mail: quartz1@quartz1.ru

111123, Москва, шоссе Энтузиастов, д31
 телефон/факс: (495) 788-8899 *многоканальный*
 e-mail: mqz@quartz1.ru