

Slide Switch

Q-864

TYPE: **MS-23D18**

SPECIFICATIONS

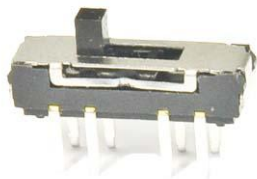

Contact Type	DP3T
Pin Width	2.5mm
Rating	DC 50V, 0.3A
Contacts Resistance	70mΩ
Insulation Resistance	100MΩ
Minimum Load	DC 500V
Dielectric Strengths	AC 500V / 1 minute
Life Test	10 000 cycles/ minute
Temperature Range	-10°C ~ +60°C
Material	Plastic & Metal

Outline Drawing

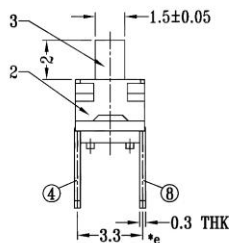
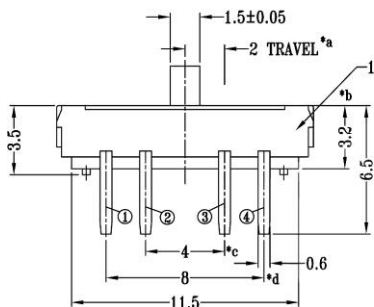
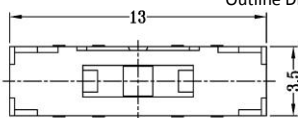

Mounting

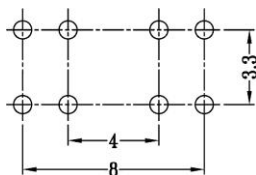

Circuitry

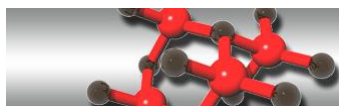
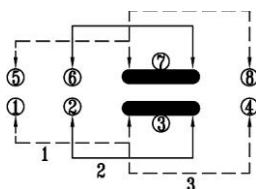

Сеть магазинов
КВАРЦ
 Радиодетали и электронные компоненты

107023, Москва, ул. Буженинова, д. 16
 телефон: (495) 963-6120
 факс: (495) 963-4994
 e-mail: quartz1@quartz1.ru

111123, Москва, шоссе Энтузиастов, д31
 телефон/факс: (495) 788-8899 *многоканальный*
 e-mail: mqz@quartz1.ru