

# ТЕЛЕФОННЫЕ КЛАВИАТУРЫ

AK-207

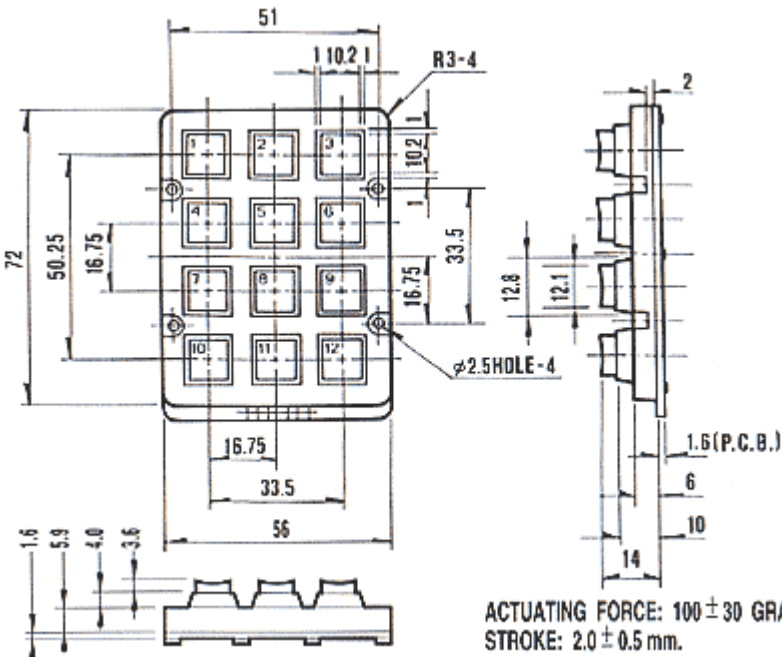

# AK-304

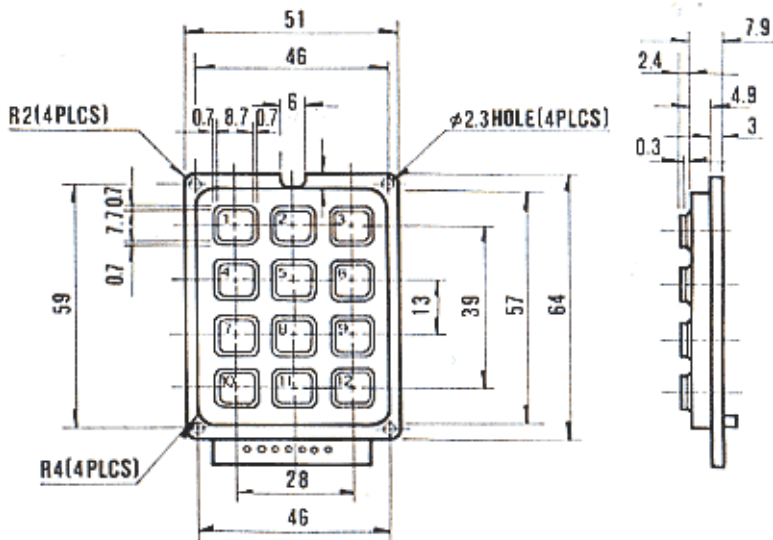

ACTUATING FORCE:  $100 \pm 30$  GRAMS.  
STROKE:  $1.4 \pm 0.4$  mm.

# AK-507

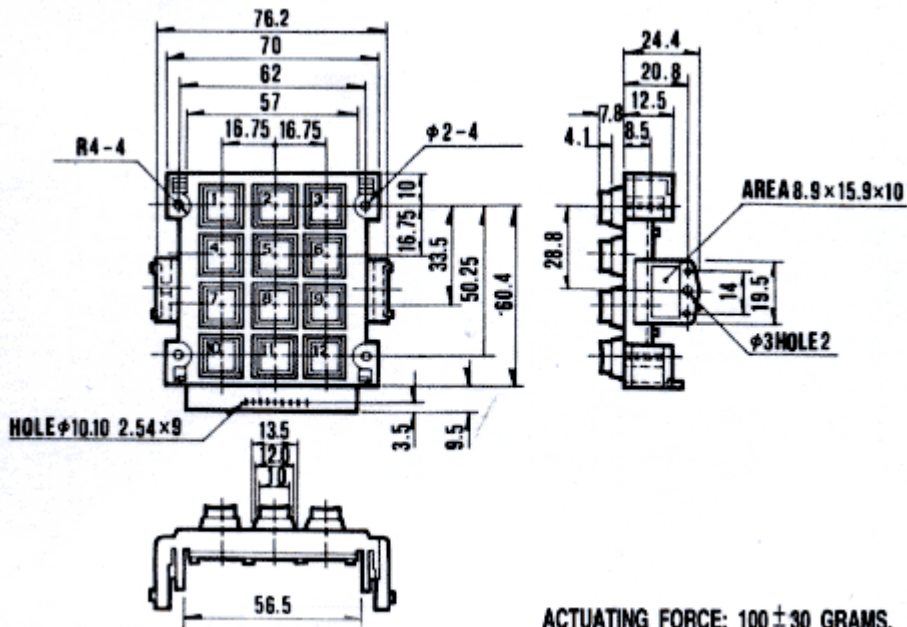

ACTUATING FORCE:  $100 \pm 30$  GRAMS.  
STROKE:  $2.0 \pm 0.5$  mm.



# AK-707

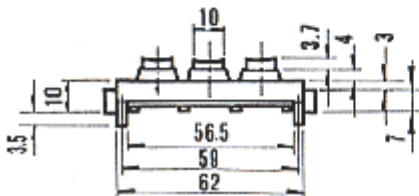
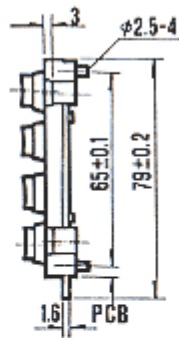
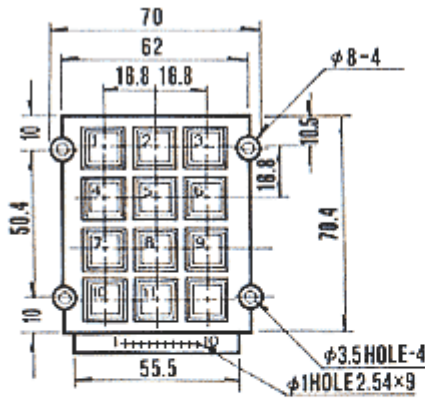

ACTUATING FORCE:  $100 \pm 30$  GRAMS.  
STROKE:  $2.0 \pm 0.5$  mm.

# AK-804

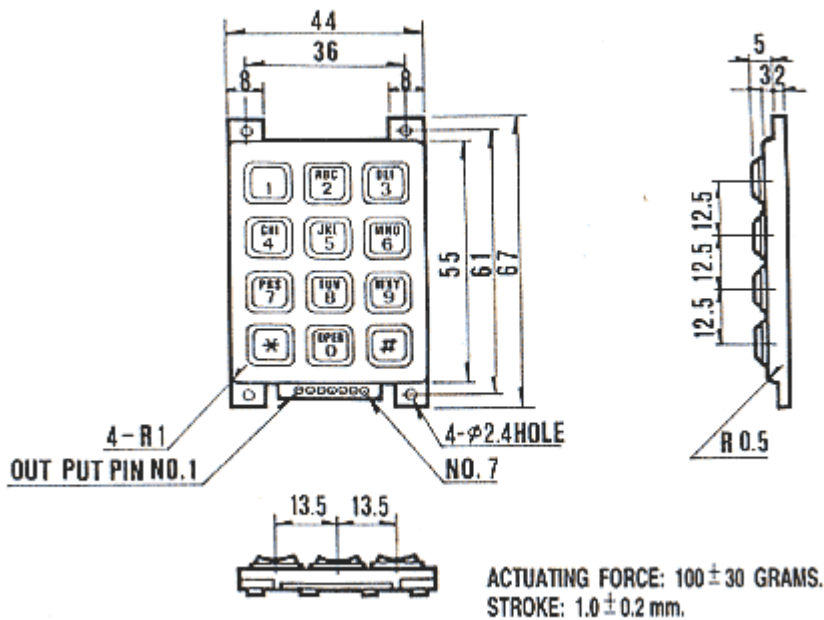
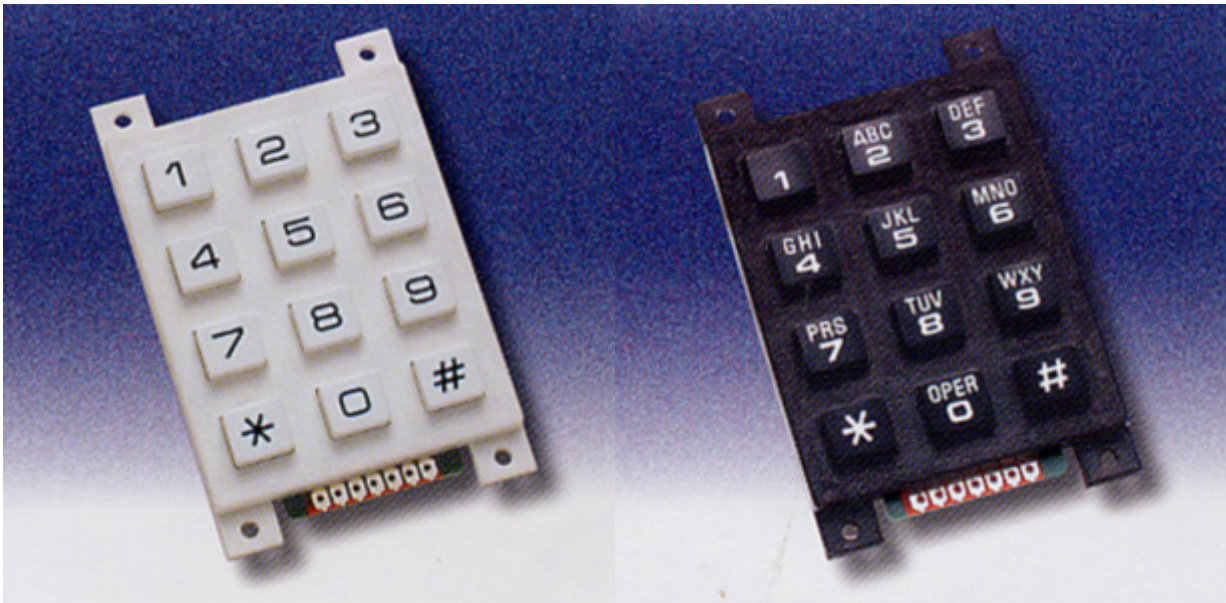





# AK-1607

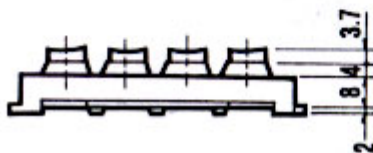
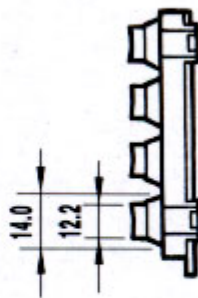
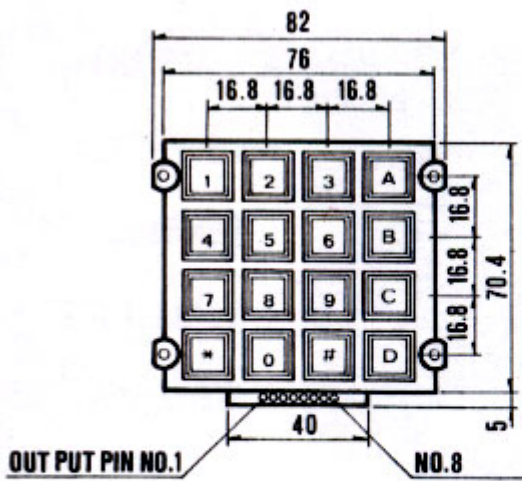

ACTUATING FORCE:  $100 \pm 30$  GRAMS.  
STROKE:  $2.0 \pm 0.5$  mm.

# AK-1607 металл

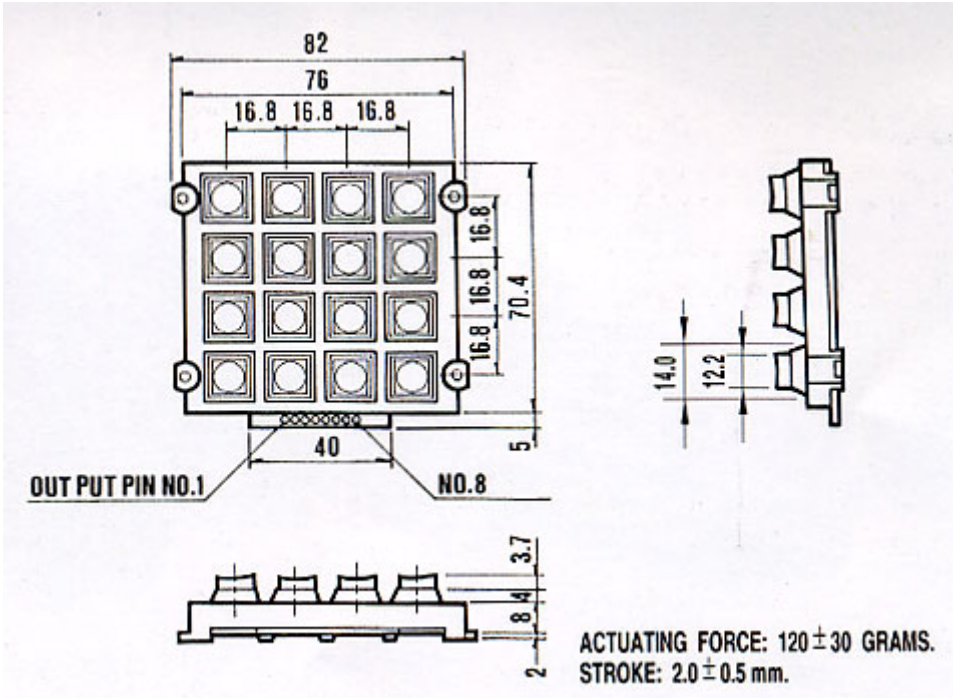
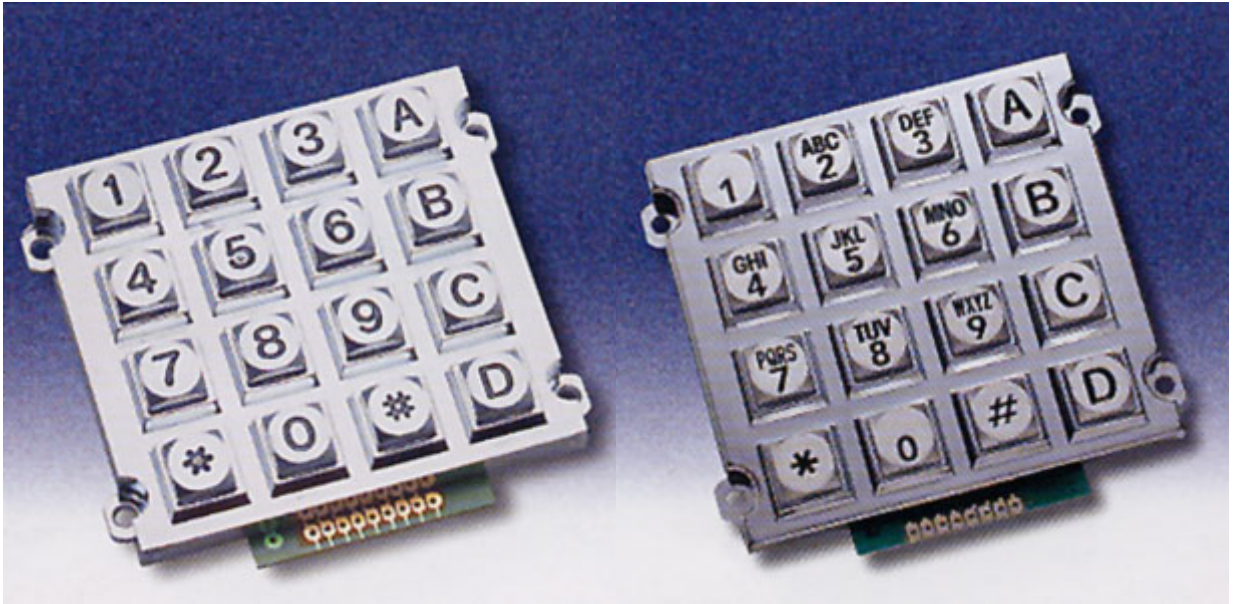



**Основные параметры:**

Режим работы контактов 24В 20мА  
 Сопротивление контактов <200 Ом  
 Ресурс 1000000 циклов на контакт  
 Рабочая температура -20 +60С

**Система обозначений:**  $\frac{AK-207-N-SSB-WP-MM}{1\ 2\ 345\ 6\ 7}$

<b>1) Номер модели</b>	207, 304, 304FM, 507, 707, 804, 1604, 1607	<b>4) Цвет кнопок</b>	W - белый B - черный G - серый I - слоновая кость S - серебристый (для металлических панелей)
<b>2) Тип символов</b>	A (алфавитно-цифровая) N (числовая)	<b>5) Цвет символов</b>	W - белый B - черный
<b>3) Цвет панели</b>	W - белый B - черный G - серый I - слоновая кость S - серебристый (для металлических панелей)	<b>6) Водонепроницаемость</b>	WP
		<b>7) Металл</b>	MM

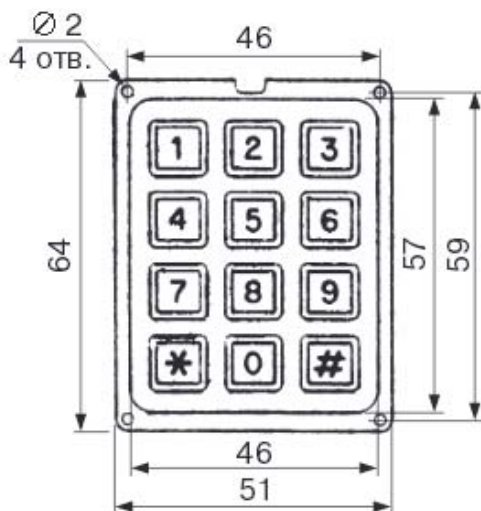
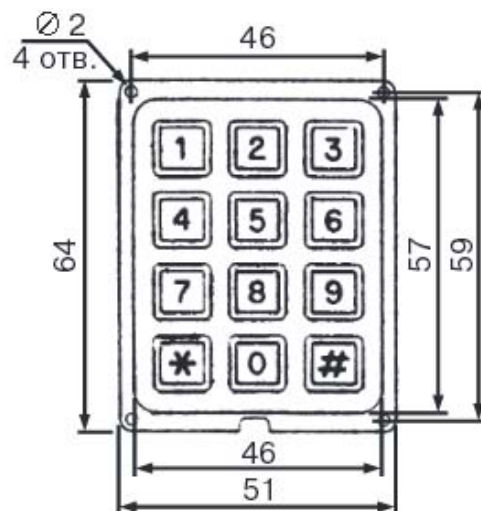
**TF-0282****TF-0284**

**TF-0286**

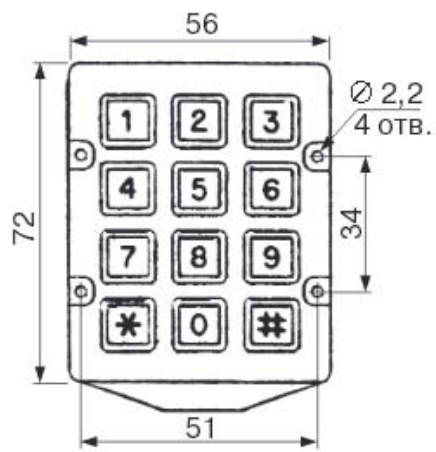

**TF-0286-1**

