

ТЕЛЕФОННЫЕ КЛАВИАТУРЫ

AK-207

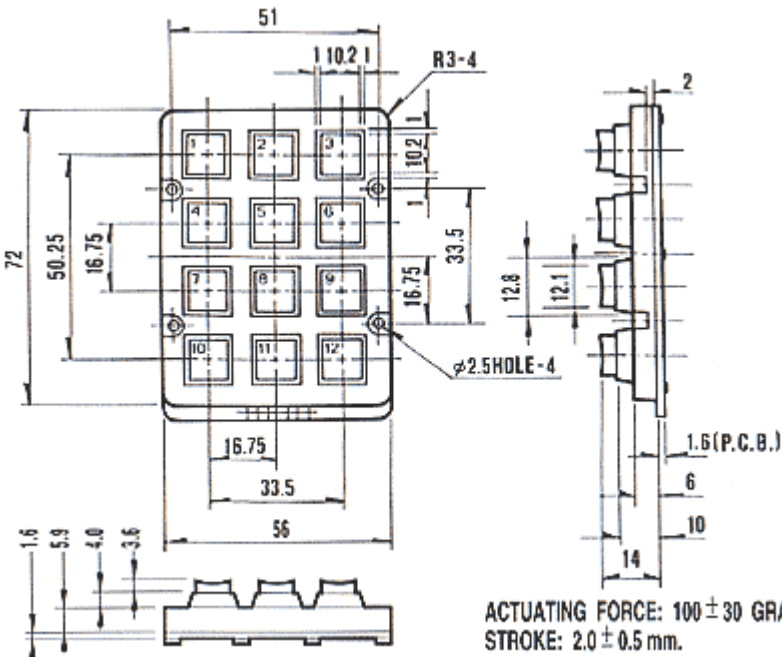

AK-304

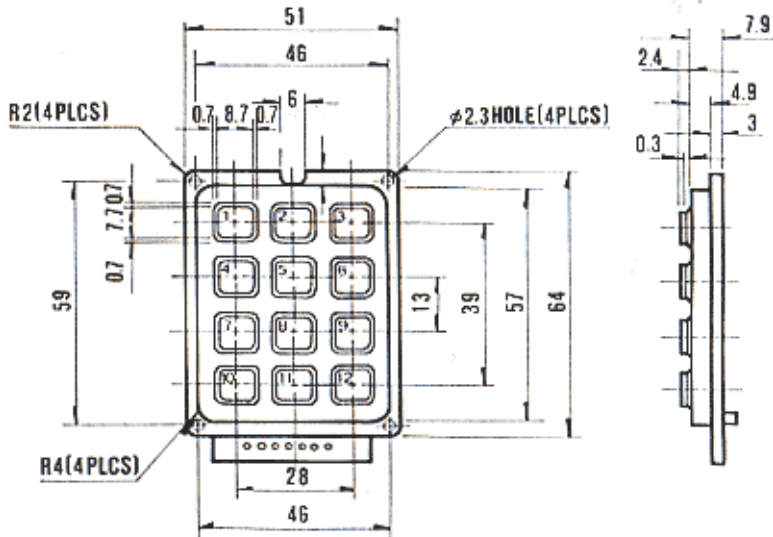

ACTUATING FORCE: 100 ± 30 GRAMS.
STROKE: 1.4 ± 0.4 mm.

AK-507

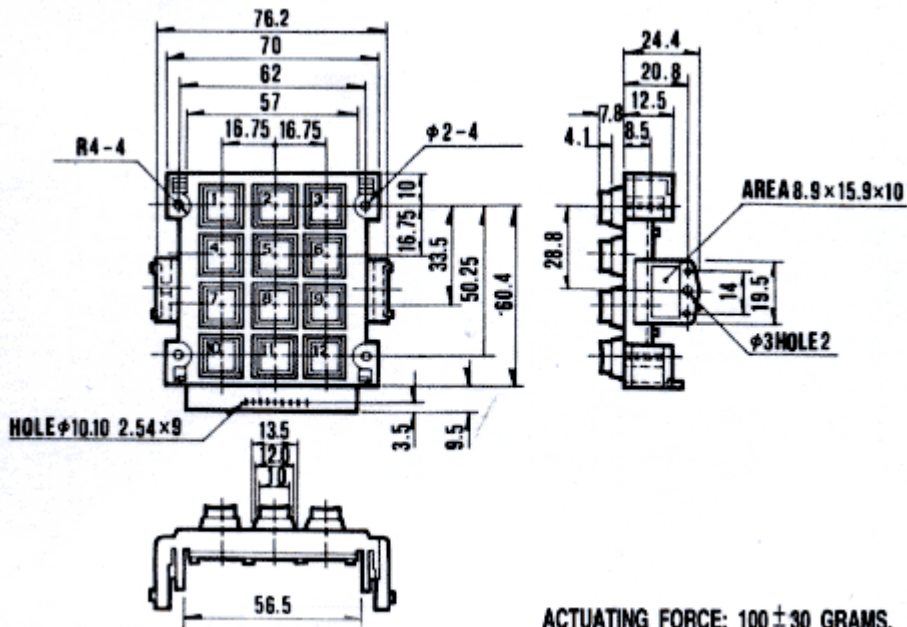

ACTUATING FORCE: 100 ± 30 GRAMS.
STROKE: 2.0 ± 0.5 mm.

AK-707

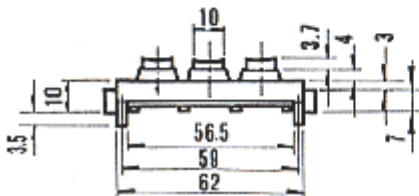
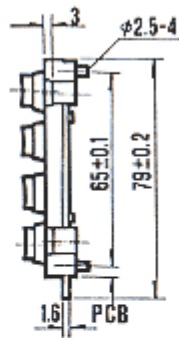
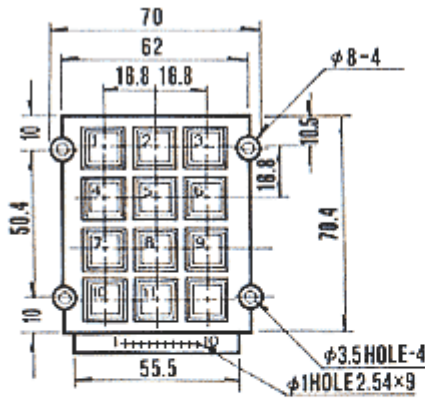

ACTUATING FORCE: 100 ± 30 GRAMS.
STROKE: 2.0 ± 0.5 mm.

AK-804

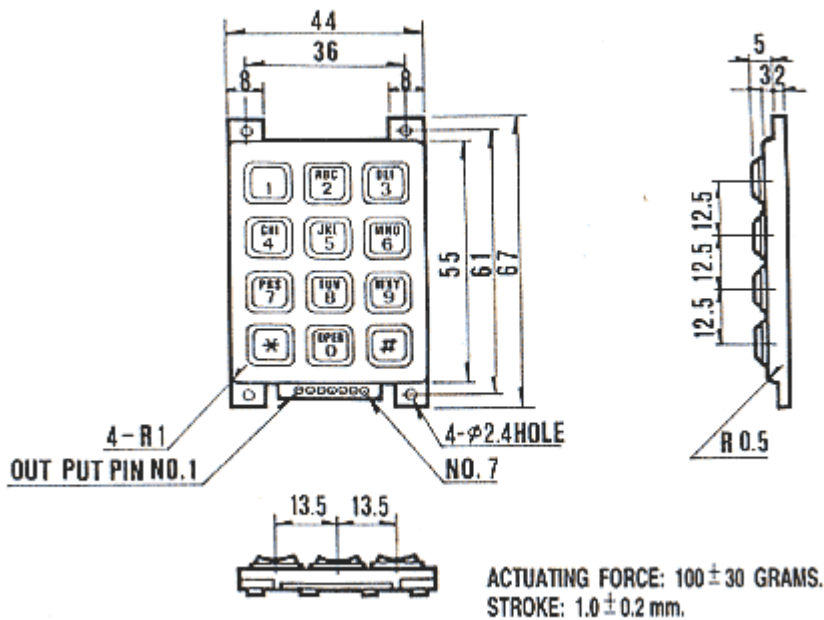
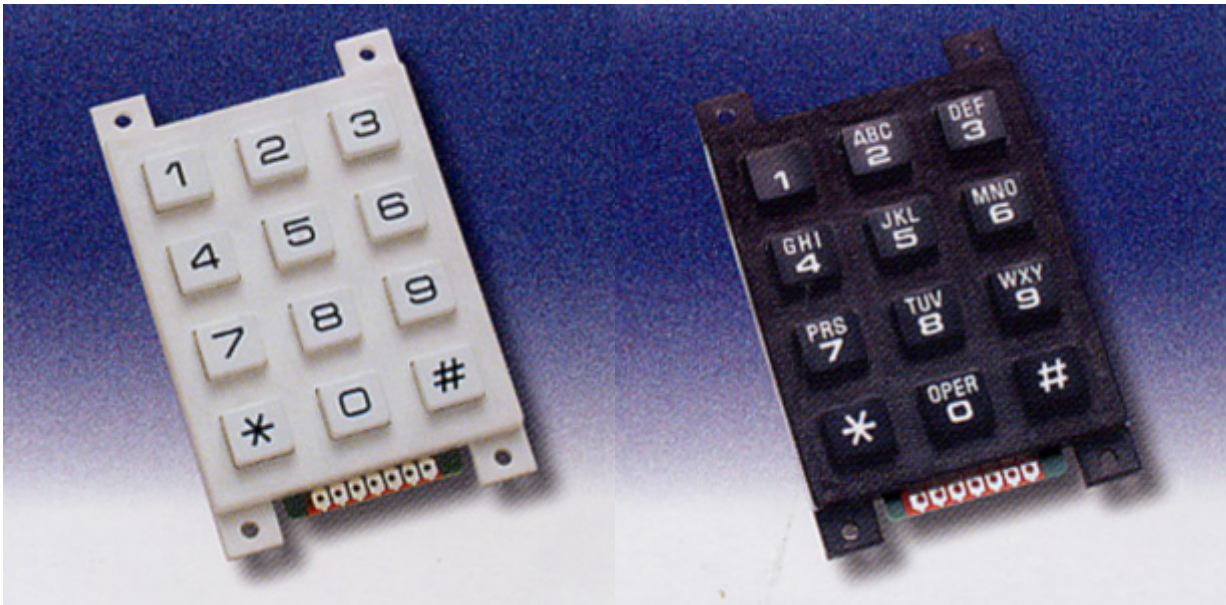

AK-1604

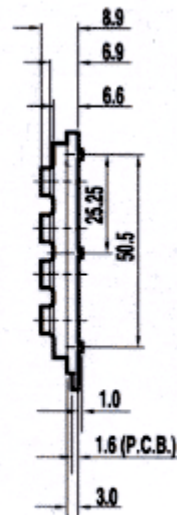
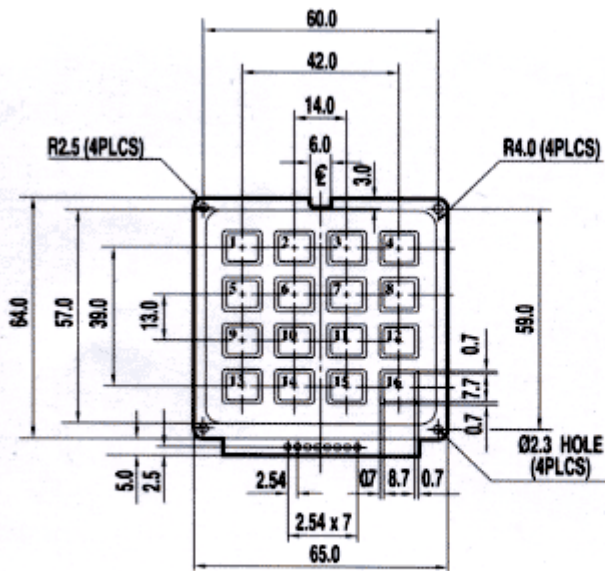

ACTUATING FORCE: 100 ± 30 GRAMS.
STROKE: 1.5 ± 0.5 mm.

AK-1607

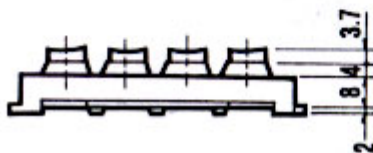
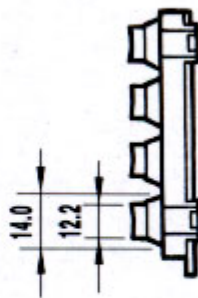
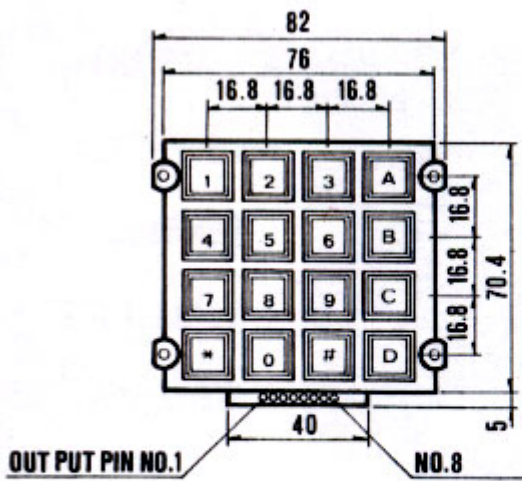

ACTUATING FORCE: 100 ± 30 GRAMS.
STROKE: 2.0 ± 0.5 mm.

AK-1607 металл

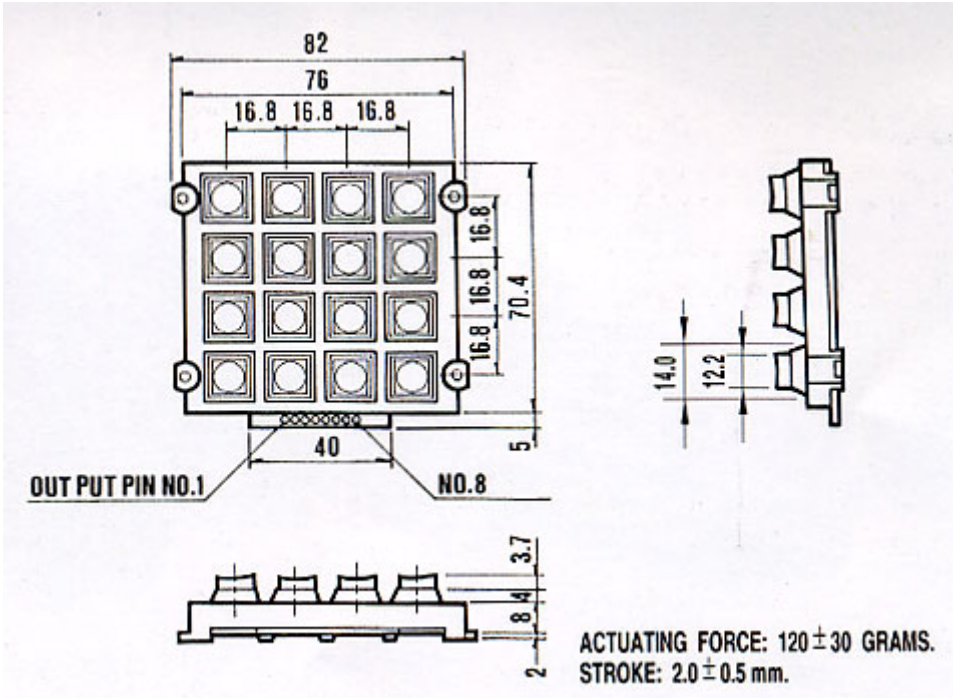
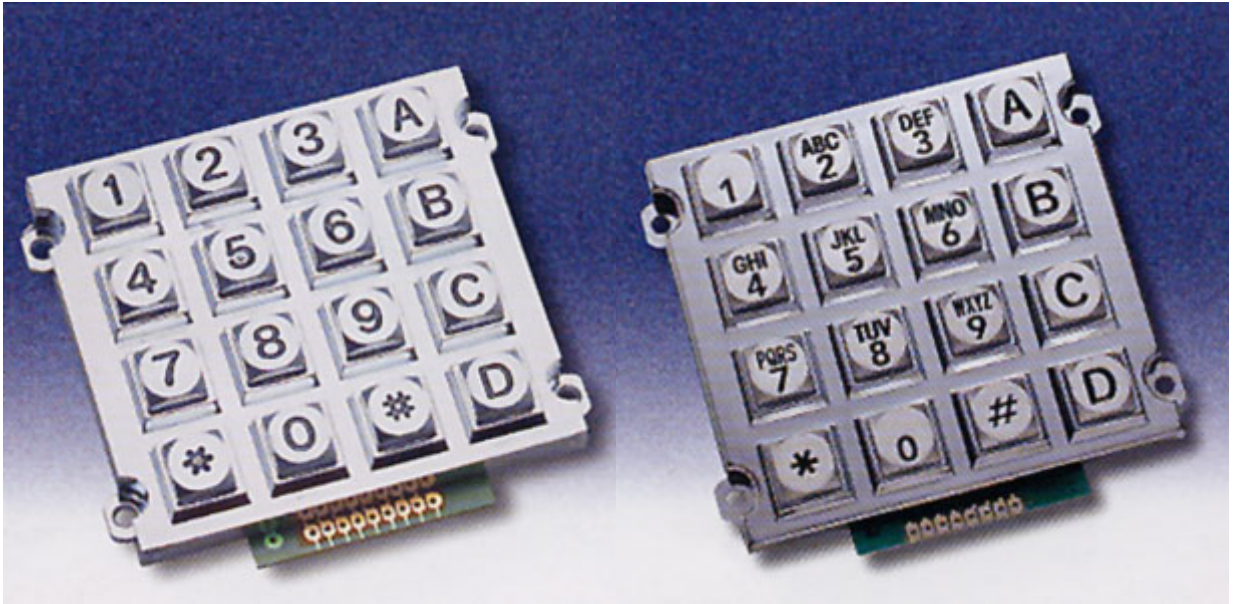

Основные параметры:

Режим работы контактов 24В 20мА
 Сопротивление контактов <200 Ом
 Ресурс 1000000 циклов на контакт
 Рабочая температура -20 +60С

Система обозначений: $\frac{AK-207-N-SSB-WP-MM}{1\ 2\ 345\ 6\ 7}$

| | | | |
|------------------------|---|-------------------------------|--|
| 1) Номер модели | 207, 304, 304FM, 507, 707, 804, 1604, 1607 | 4) Цвет кнопок | W - белый B - черный G - серый I - слоновая кость S - серебристый (для металлических панелей) |
| 2) Тип символов | A (алфавитно-цифровая) N (числовая) | 5) Цвет символов | W - белый B - черный |
| 3) Цвет панели | W - белый B - черный G - серый I - слоновая кость S - серебристый (для металлических панелей) | 6) Водонепроницаемость | WP |
| | | 7) Металл | MM |

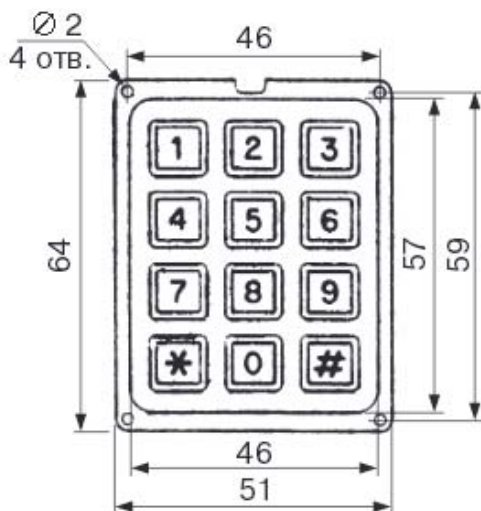
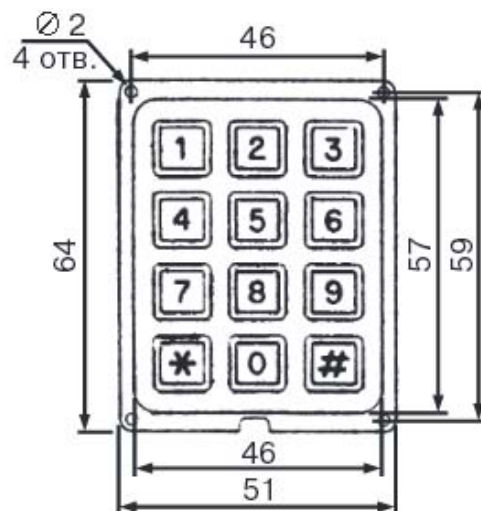
TF-0282**TF-0284**

TF-0286

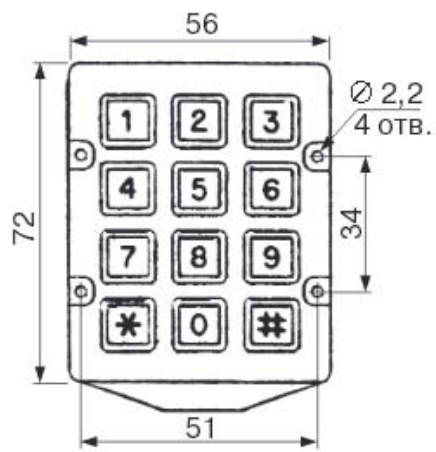

TF-0286-1

